



广州凯加未来科技有限公司

GUANGZHOU K PLUS FUTURE TECH CO., LTD.



竹节灯

BAMBOO

2024 (Ø50)

专利号: ZL 2020 3 0079589.5

Patent number : ZL 2020 3 0079589.5

● “竹节灯” 家族



(Ø80)



(Ø50)



(Ø30)

● “竹节灯”的常用高度

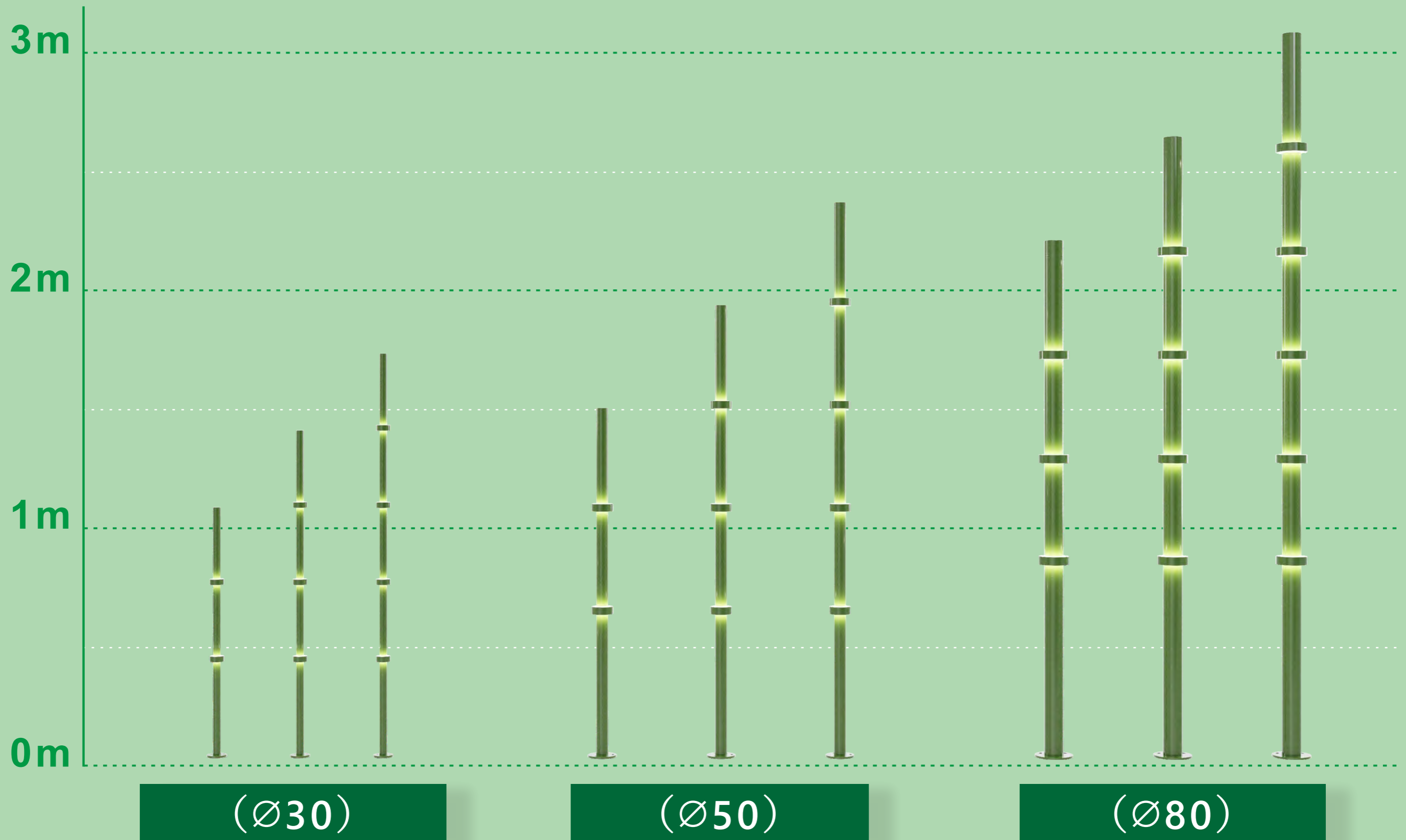

“竹节灯”型号定义规则

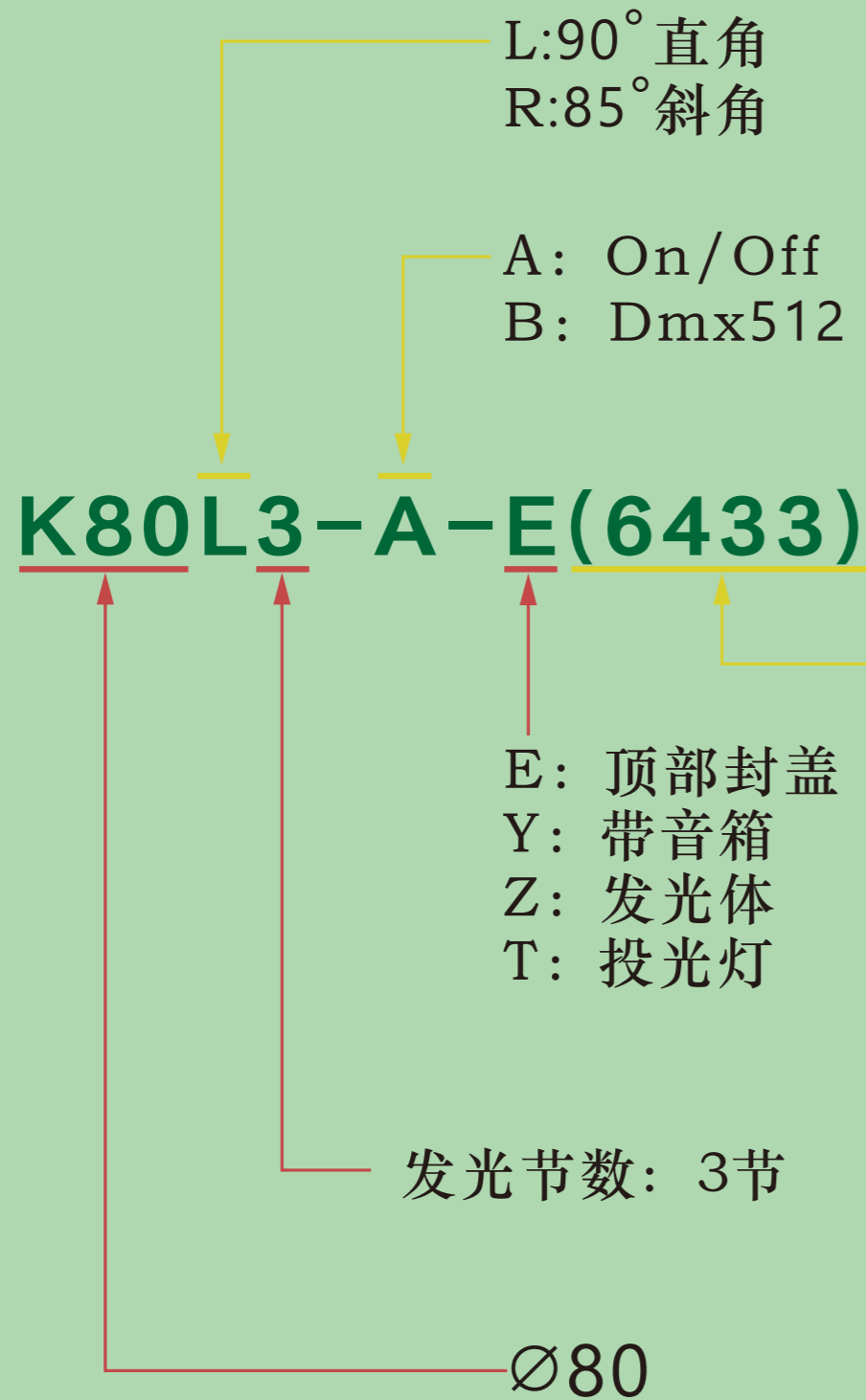

NT: 网络音箱
BT: 蓝牙音箱

例: 64**NT**33
 6433**NT**
 6433**BT**

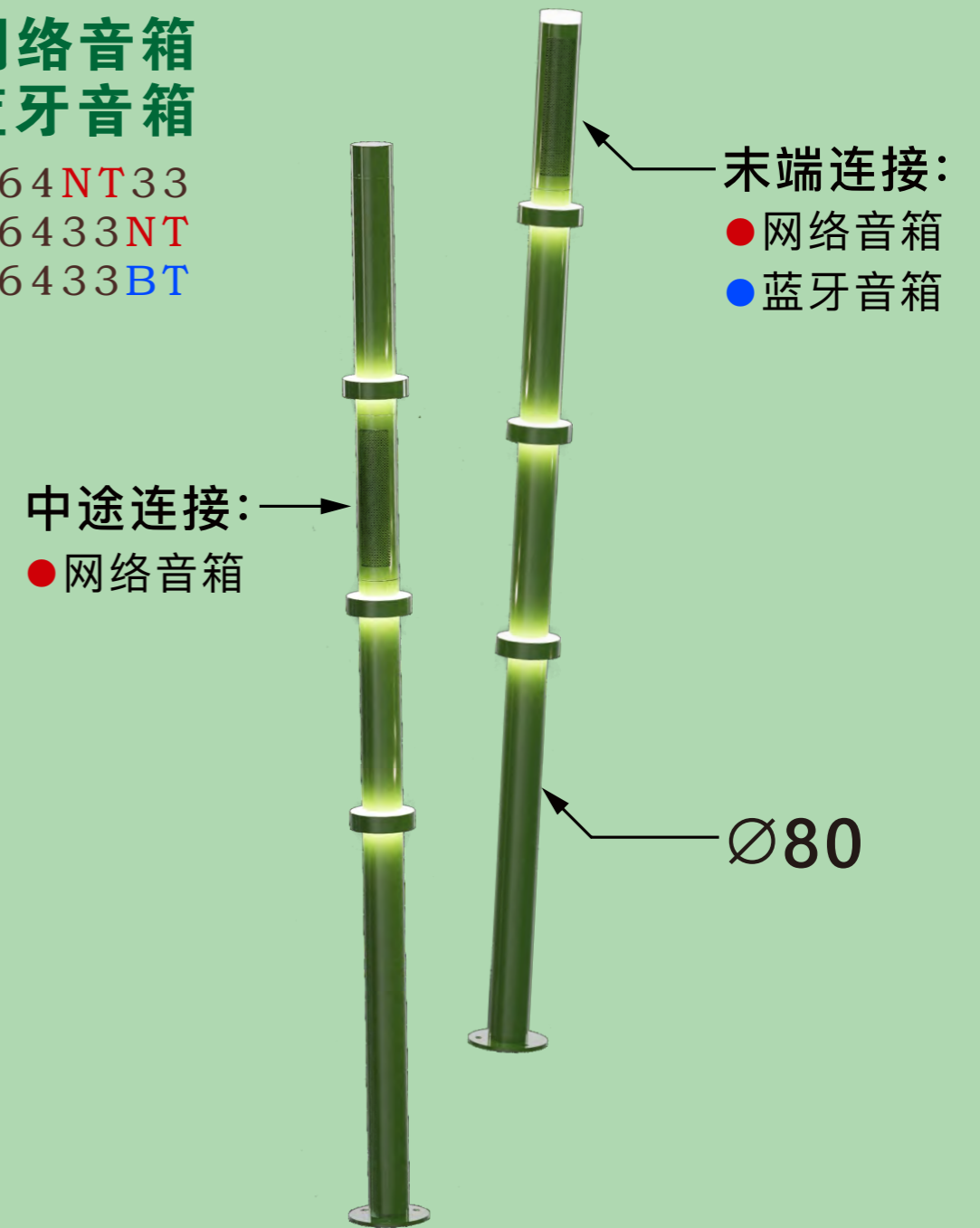

说明: (NT)网络音箱可以作为中途连接和末端
 (BT)蓝牙音箱只能为末端

● “竹节灯”的组件

顶部投光灯: T

发光体: Z



顶部固定/顶盖:
E



中途网络音箱:
NT



蓝牙音箱: BT
或
网络音箱: NT



发光节

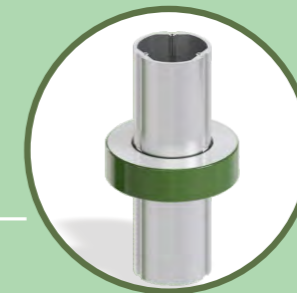

中途连接杆

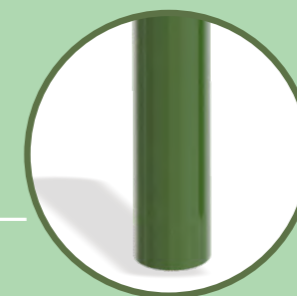

垂直底座

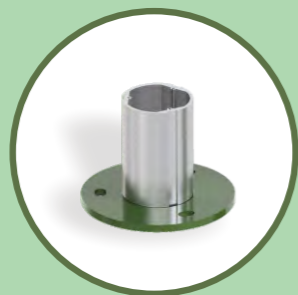

85° 底杆



(Ø80)

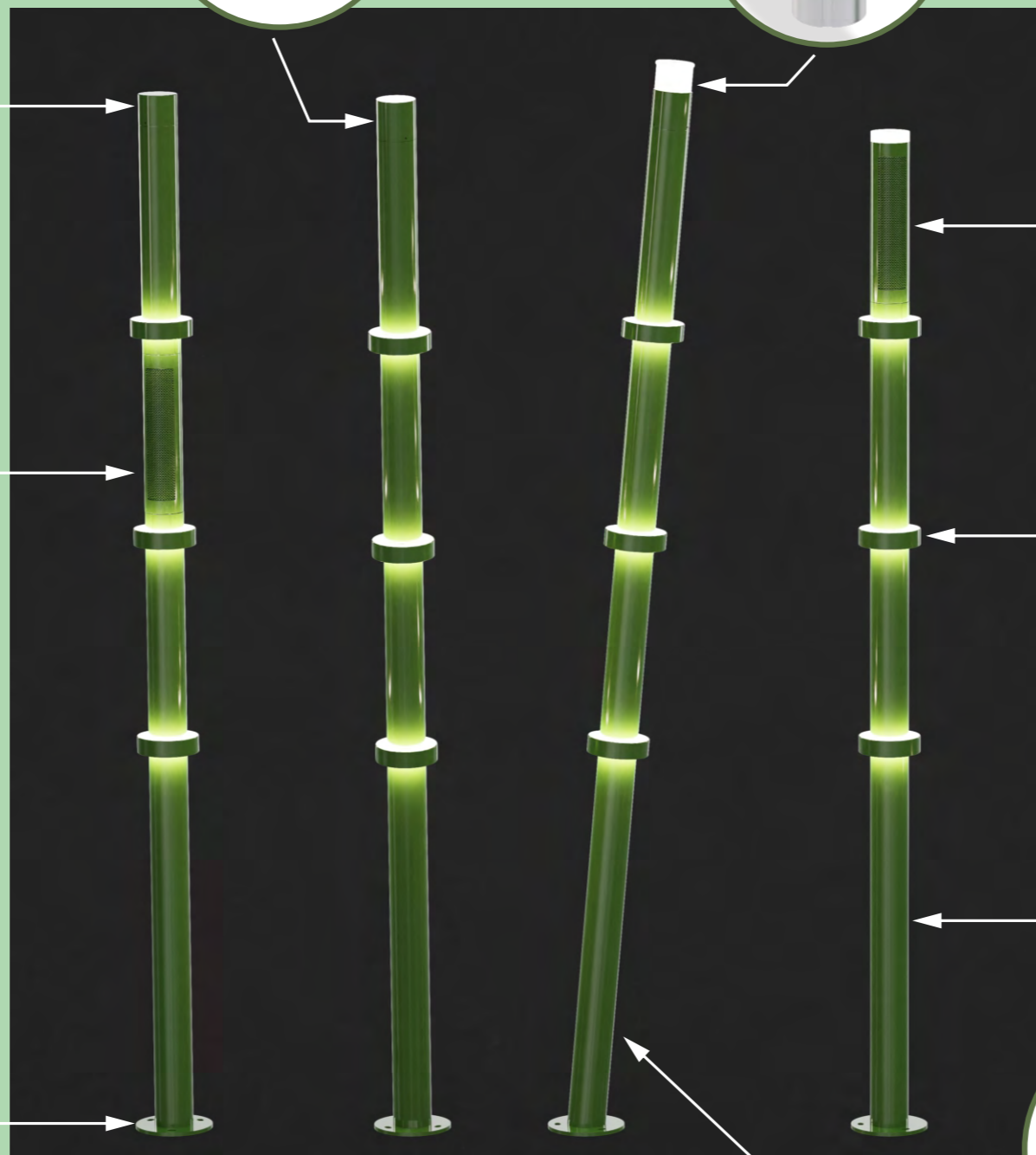



发光节



垂直底杆



85°底杆

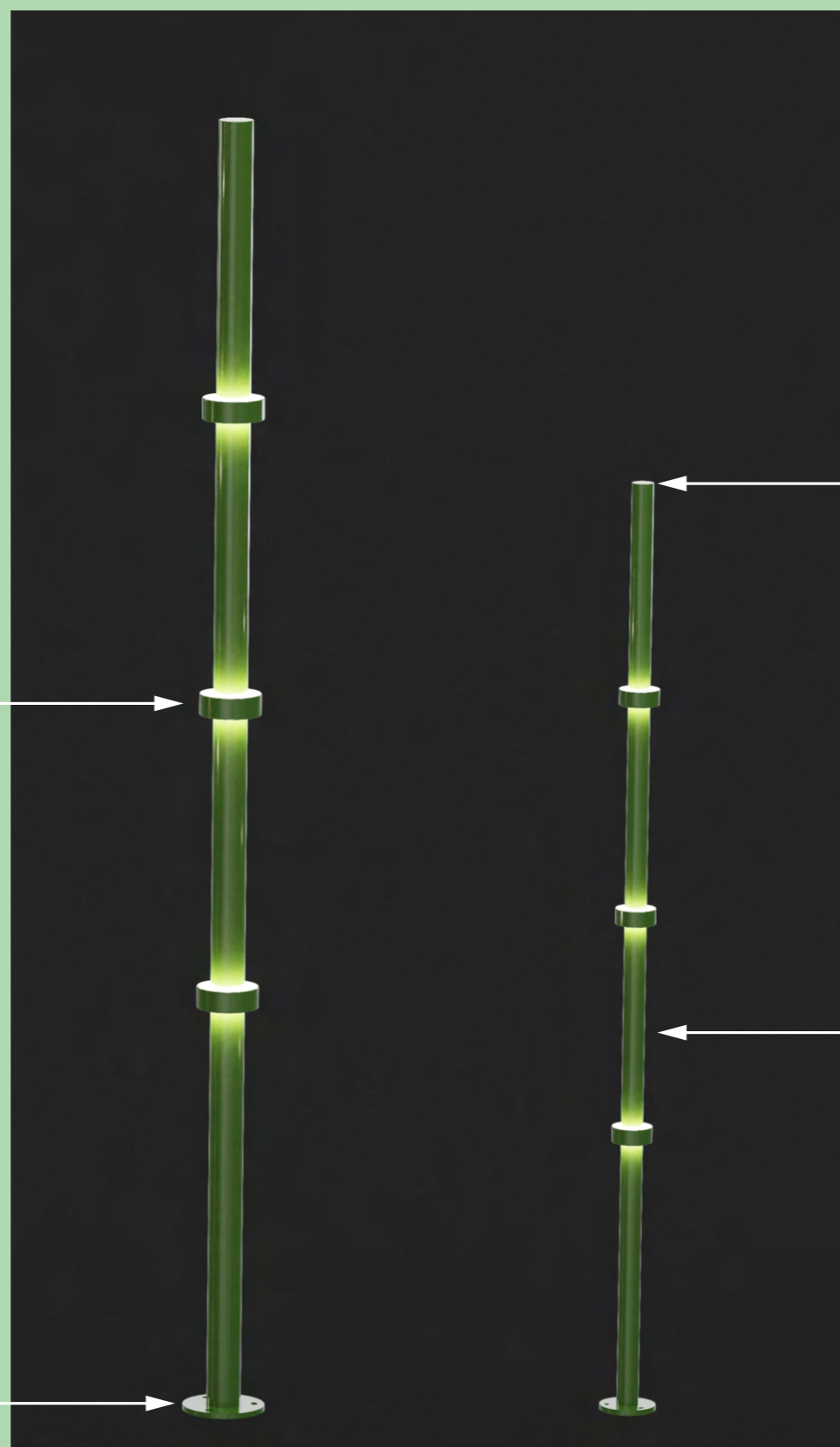

(Ø50)

(Ø30)

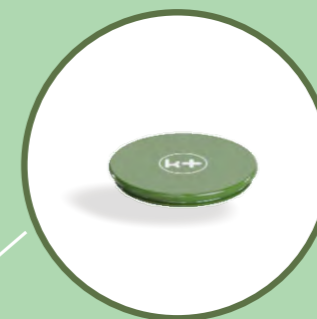

顶盖:E

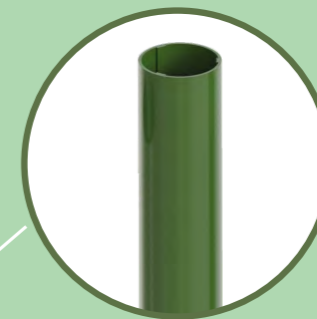

中途连接杆

● “竹节灯” 组件总览表

	Ø80	Ø50	Ø30
底杆	600/800	400/600	300/400
中途杆	300、400	200、300、400	200、300
发光节	9W(单色); 12W(RGB)	6W(单色); 9W(RGB)	1.5W(单色)
发光体	6W(单色); 9W(RGB)	/	/
投光灯	6W(单色); 9W(RGB)	/	/
蓝牙音箱	25W(功放)+2W(灯)	/	/
网络音箱	30W	/	/

(单位: 毫米/mm)



竹节灯产品精选

K+创研团队以建筑学思维，抽取“竹子”的形态特点，运用照明技术开发出会“发光的竹节”，命名为“竹节灯”。

“竹节灯”由模组拼接而成，用户可以(在K+团队的协助下)自定义高度、“发光节”数量、节距，乃至倾斜度。

我们把一些常用的规格供用户参考。

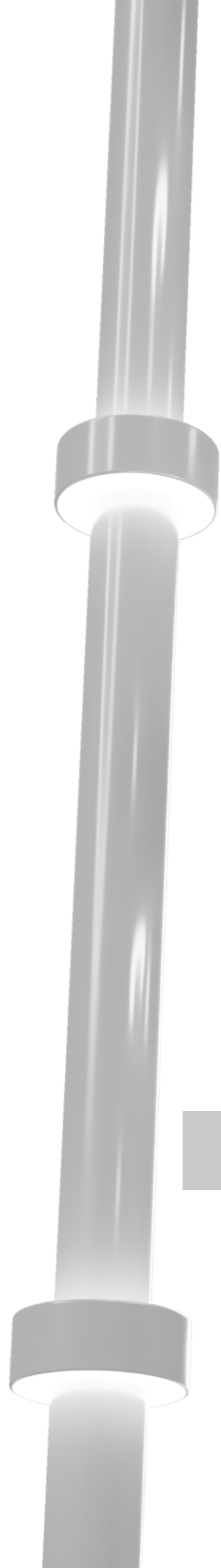

Ø30



Ø50



Ø80

Ø50

①竹杆：竹杆有五种不同长度可供客户自由组合（客户可定制）

① Bamboo Pole: For Lengths For Option (Customization Available)

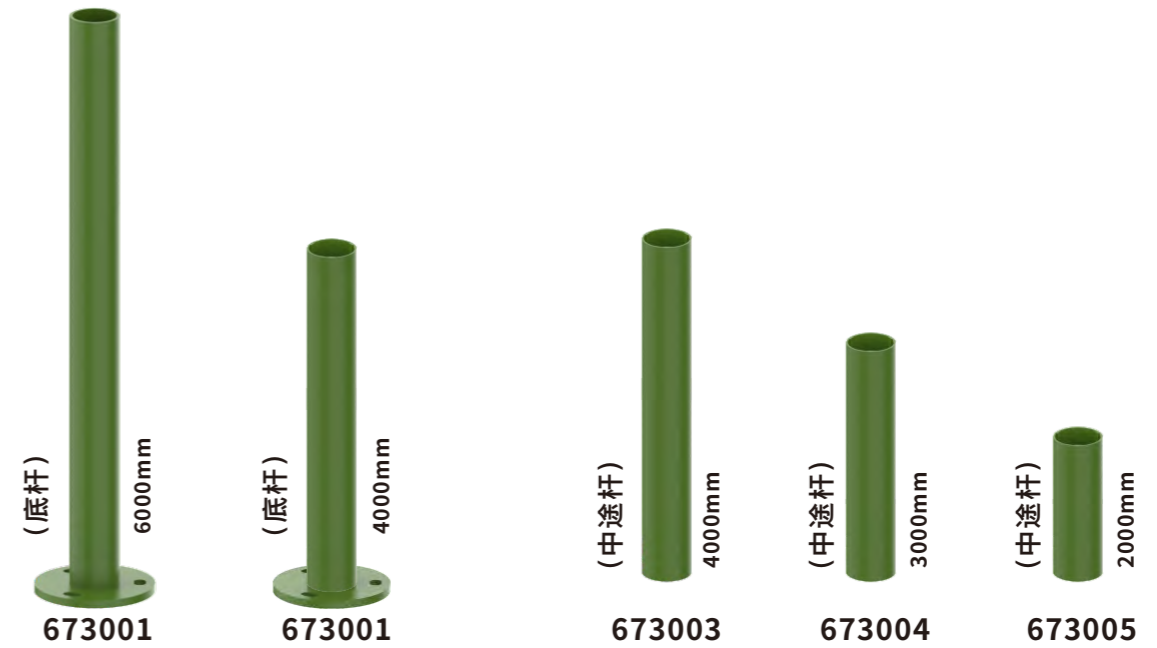

②地面固定系统：地面固定系统有两种不同角度供客户选择（客户可定制）

② Ground Fixation System: Ground Fixation System With Two Angles For Option (Customization Available)

373001

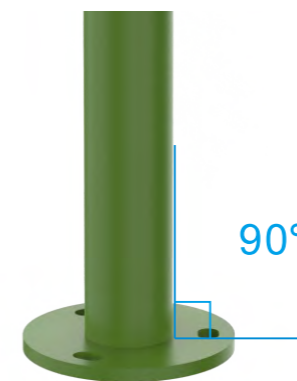

90°

90°地面固定系统

90° Ground Fixation System

373002



85°

85°地面固定系统

85° Ground Fixation System

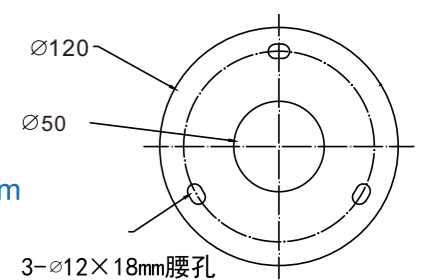
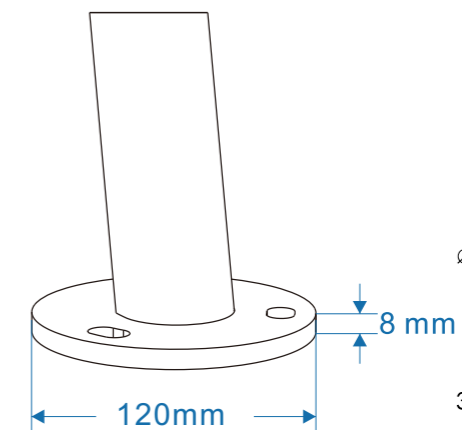
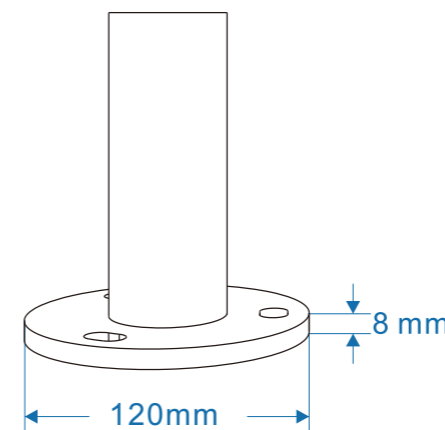

Ø50

①发光竹节

①Luminous Bamboo Joint

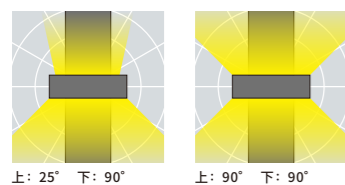
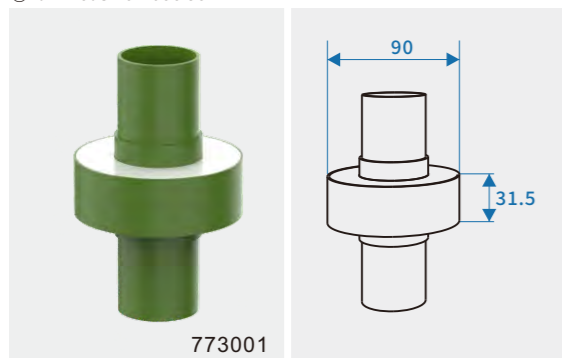

材质：铝
厚度：3mm
Material: Aluminum Alloy
Thickness: 3mm

功率Power: 6W/节
防护等级IP Rating: Ip65
输入电压Input Voltage: DC24V
控制Control: on or off
显色性Ra: Ra>85
色温CCT: 3000K/4000K
光源品牌LED Brand: CREE / OSRAM
灯体颜色Painting Color: ■
环境温度Operating Temperature: -30°C~+50°C
适用范围Scope of application: 户外/室内Outdoor / Indoor

③顶盖

③Top Cover

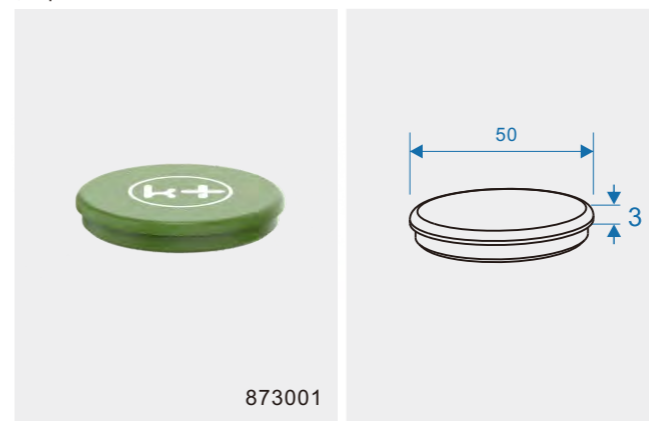

材质：铝
厚度：3mm
Material: Aluminum Alloy
Thickness: 3mm

②发光竹节

②Luminous Bamboo Joint

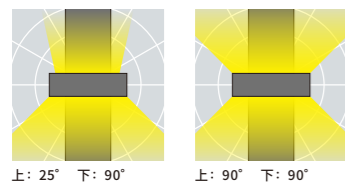
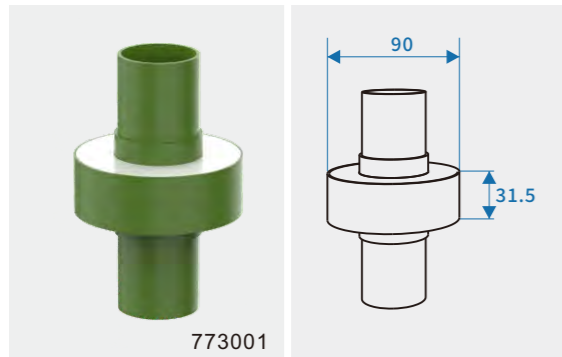

材质：铝
厚度：3mm
Material: Aluminum Alloy
Thickness: 3mm

功率Power: 9W/节
防护等级IP Rating: Ip65
输入电压Input Voltage: DC24V
控制Control: DMX512
显色性Ra: Ra>85
色温CCT: RGB
光源品牌LED Brand: CREE / OSRAM
灯体颜色Painting Color: ■
环境温度Operating Temperature: -30°C~+50°C
适用范围Scope of application: 户外/室内Outdoor / Indoor

Ø50

灯具编号: K50L2-A-E/K50R2-A-E
Luminaire Serial Number: K50L2-A-E/K50R2-A-E

功率Power: 12W(2x6W/节)
光模组Light Module: 2组 (发光竹节x2)
防护等级IP Rating: Ip65
输入电压Input Voltage: DC24V
控制Control: on or off
显色性Ra: Ra>85
色温CCT: 3000K/4000K
光源品牌LED Brand: CREE / OSRAM
灯体颜色Painting Color: ■
环境温度Operating Temperature: -30°C~+50°C
适用范围Scope of application: 户外Outdoor/室内Indoor
倾角Inclination: 90°/85°

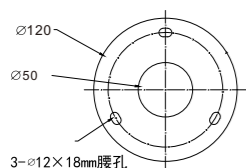
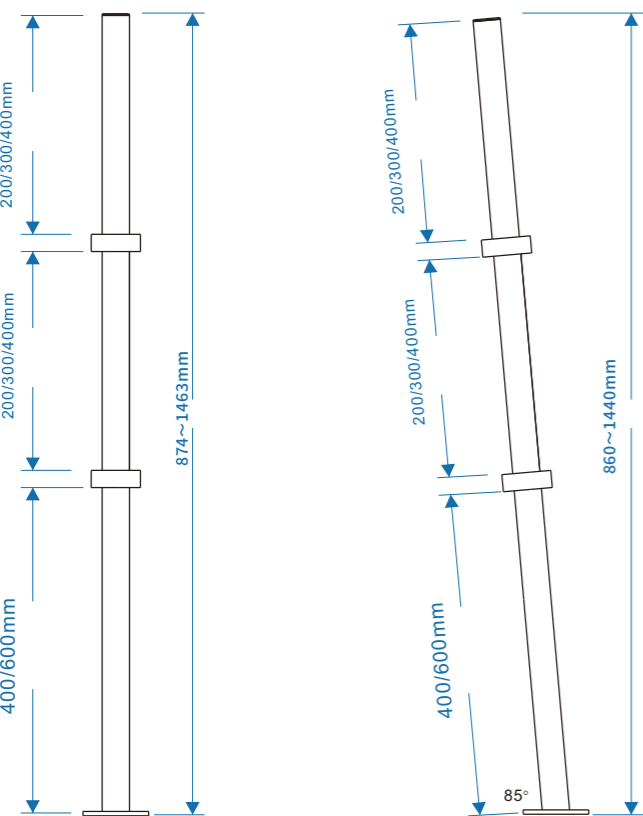

K50L2-A-E

K50R2-A-E

颜色: ■
Colour: Green

单位Unit: mm

灯具编号: K50L3-A-E/K50R3-A-E
Luminaire Serial Number: K50L3-A-E/K50R3-A-E

功率Power: 18W(3x6W/节)
光模组Light Module: 3组 (发光竹节x3)
防护等级IP Rating: Ip65
输入电压Input Voltage: DC24V
控制Control: on or off
显色性Ra: Ra>85
色温CCT: 3000K/4000K
光源品牌LED Brand: CREE / OSRAM
灯体颜色Painting Color: ■
环境温度Operating Temperature: -25°C~+40°C
适用范围Scope of application: 户外Outdoor/室内Indoor
倾角Inclination: 90°/85°

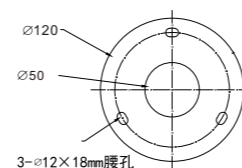
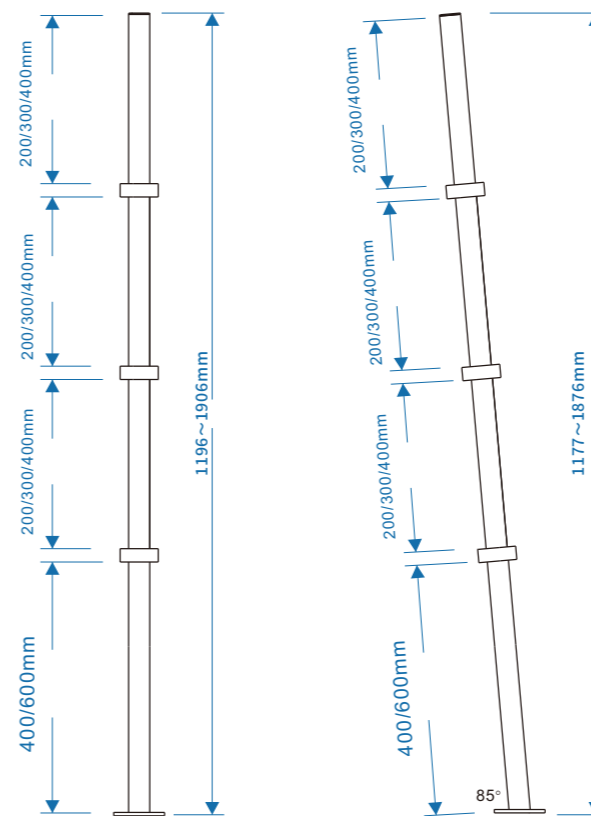

K50L3-A-E

K50R3-A-E

颜色: ■
Colour: Green

单位Unit: mm

Ø50

灯具编号: K50L2-B-E/K50R2-B-E

Luminaire Serial Number: K50L2-B-E/K50R2-B-E

功率Power: 18W(2x9W/节)

光模组Light Module: 2组 (发光竹节x2)

防护等级IP Rating: Ip65

输入电压Input Voltage: DC24V

控制Control: DMX512

显色性Ra: Ra>85

色温CCT: RGB

光源品牌LED Brand: CREE / OSRAM

灯体颜色Painting Color: ■

环境温度Operating Temperature: -30°C~+50°C

适用范围Scope of application: 户外Outdoor/室内Indoor

倾角Inclination: 90°/85°

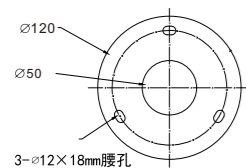
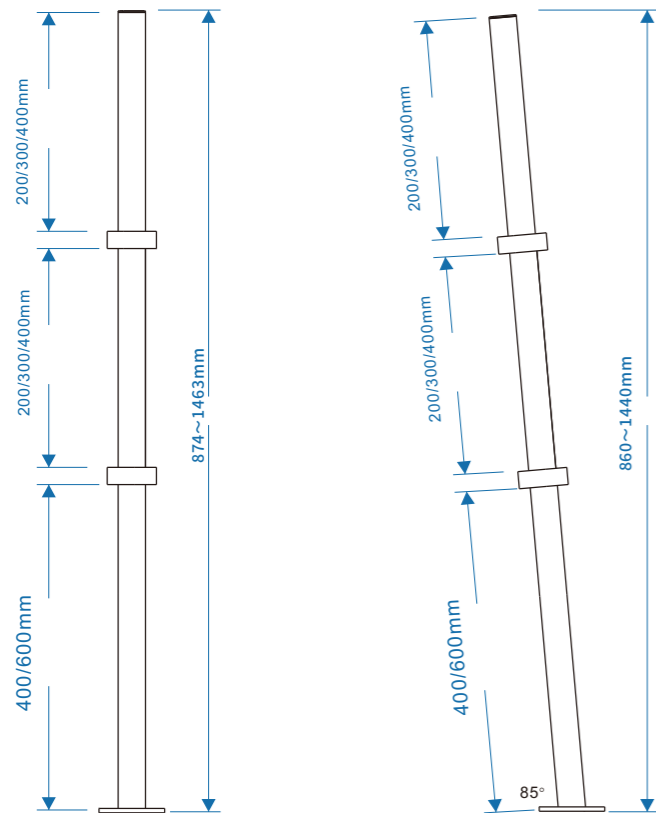

单位Unit: mm

颜色: ■
Colour: Green



K50L2-B-E

K50R2-B-E

灯具编号: K50L3-B-E/K50R3-B-E

Luminaire Serial Number: K50L3-B-E/K50R3-B-E

功率Power: 27W(3x9W/节)

光模组Light Module: 3组 (发光竹节x3)

防护等级IP Rating: Ip65

输入电压Input Voltage: DC24V

控制Control: DMX512

显色性Ra: Ra>85

色温CCT: RGB

光源品牌LED Brand: CREE / OSRAM

灯体颜色Painting Color: ■

环境温度Operating Temperature: -25°C~40°C

适用范围Scope of application: 户外Outdoor/室内Indoor

倾角Inclination: 90°/85°

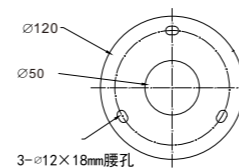
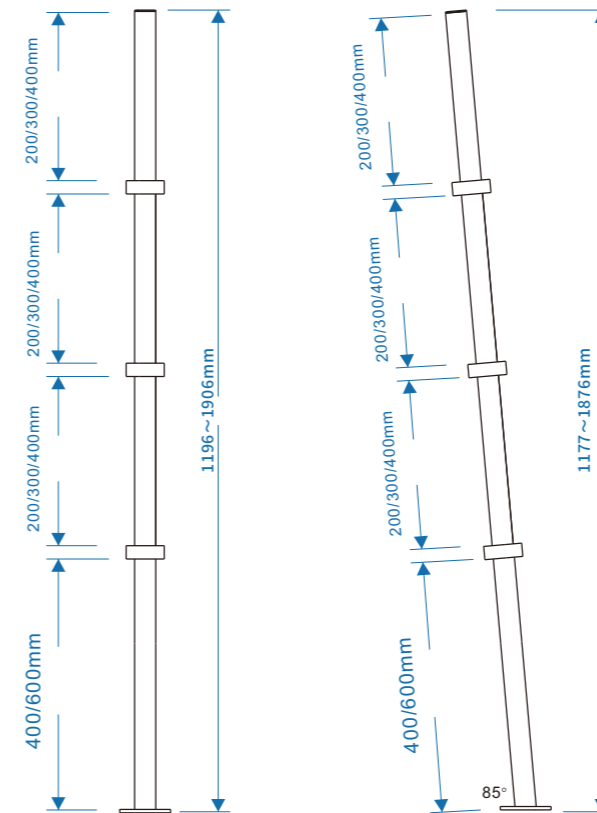

单位Unit: mm

颜色: ■
Colour: Green

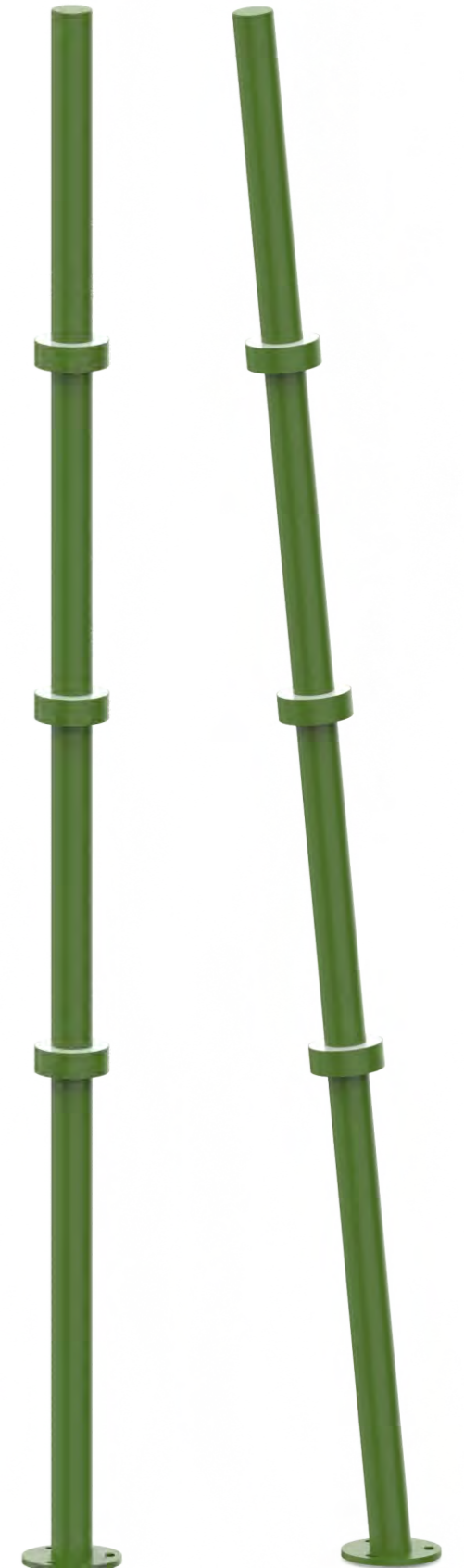

K50L3-B-E

K50R3-B-E

Ø50

灯具编号: K50L4-A-E/K50R4-A-E

Luminaire Serial Number: K50L4-A-E/K50R4-A-E

功率Power: 24W(4x6W/节)

光模组Light Module: 4组 (发光竹节x4)

防护等级IP Rating: Ip65

输入电压Input Voltage: DC24V

控制Control: on or off

显色性Ra: Ra>85

色温CCT: 3000K/4000K

光源品牌LED Brand: CREE / OSRAM

灯体颜色Painting Color: ■

环境温度Operating Temperature: -30°C~+50°C

适用范围Scope of application: 户外Outdoor/室内Indoor

倾角Inclination: 90°/85°

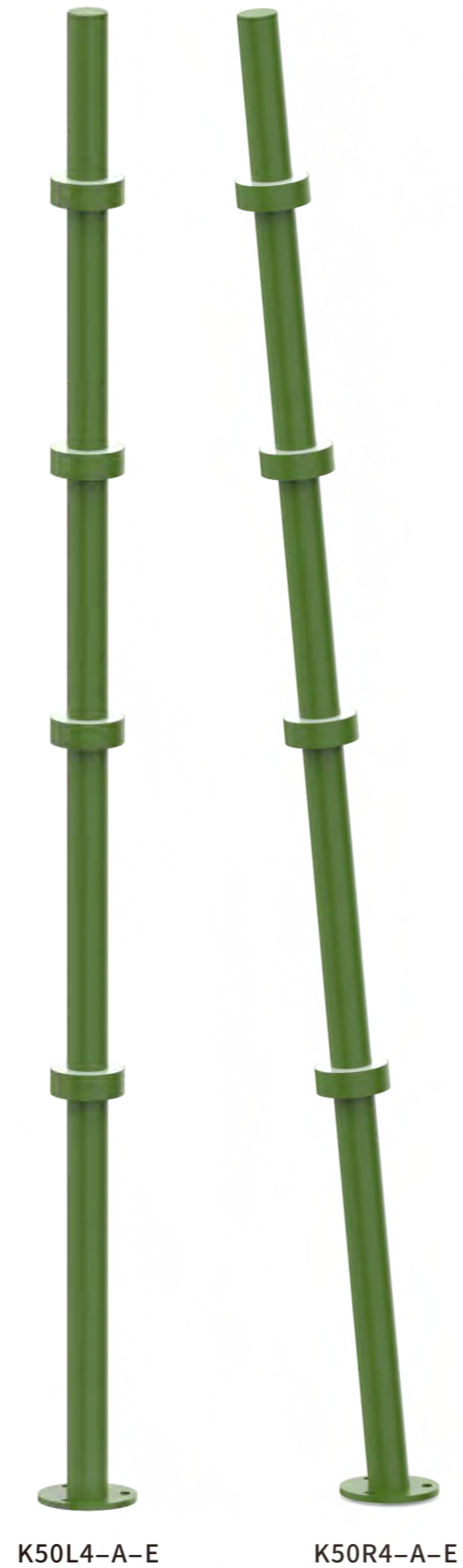
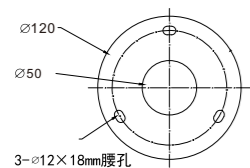
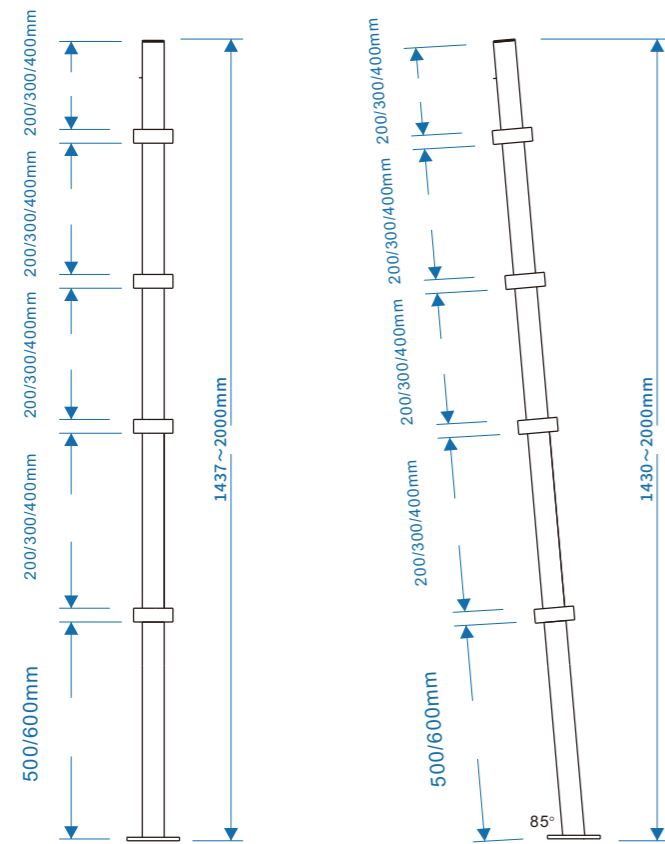

K50L4-A-E

K50R4-A-E

颜色: ■
Colour: Green

单位Unit: mm

灯具编号: K50L5-A-E/K50R5-A-E

Luminaire Serial Number: K50L5-A-E/K50R5-A-E

功率Power: 30W(5x6W/节)

光模组Light Module: 5组 (发光竹节x5)

防护等级IP Rating: Ip65

输入电压Input Voltage: DC24V

控制Control: on or off

显色性Ra: Ra>85

色温CCT: 3000K/4000K

光源品牌LED Brand: CREE / OSRAM

灯体颜色Painting Color: ■

环境温度Operating Temperature: -25°C~40°C

适用范围Scope of application: 户外Outdoor/室内Indoor

倾角Inclination: 90°/85°

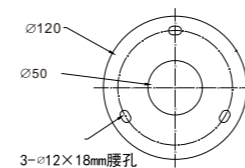
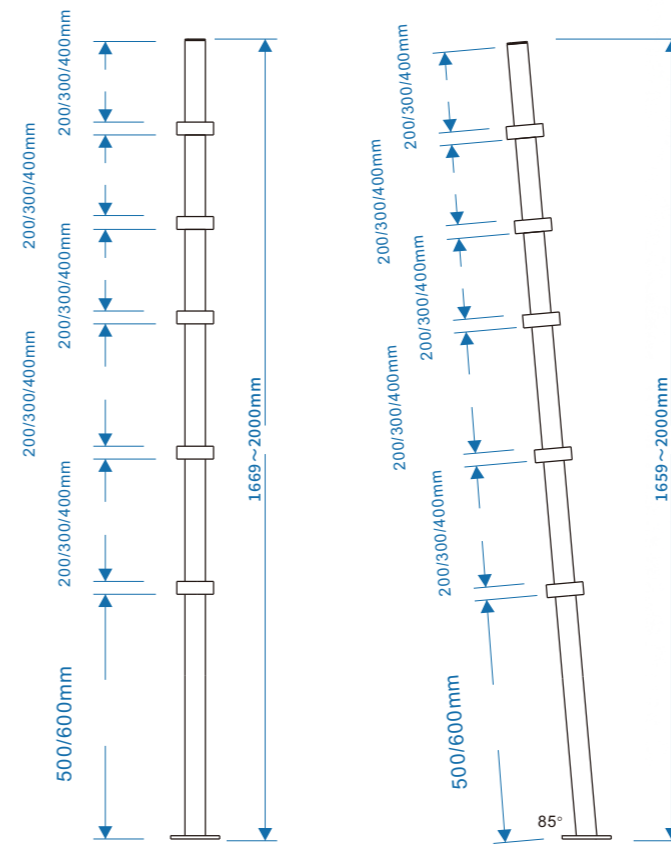

K50L5-A-E

K50R5-A-E

颜色: ■
Colour: Green

单位Unit: mm

Ø50

灯具编号: K50L4-B-E/K50R4-B-E

Luminaire Serial Number: K50L4-B-E/K50R4-B-E

功率Power: 36W(4x9W/节)

光模组Light Module: 4组 (发光竹节x4)

防护等级IP Rating: Ip65

输入电压Input Voltage: DC24V

控制Control: DMX512

显色性Ra: Ra>85

色温CCT: RGB

光源品牌LED Brand: CREE / OSRAM

灯体颜色Painting Color: ■

环境温度Operating Temperature: -30°C~+50°C

适用范围Scope of application: 户外Outdoor/室内Indoor

倾角Inclination: 90°/85°

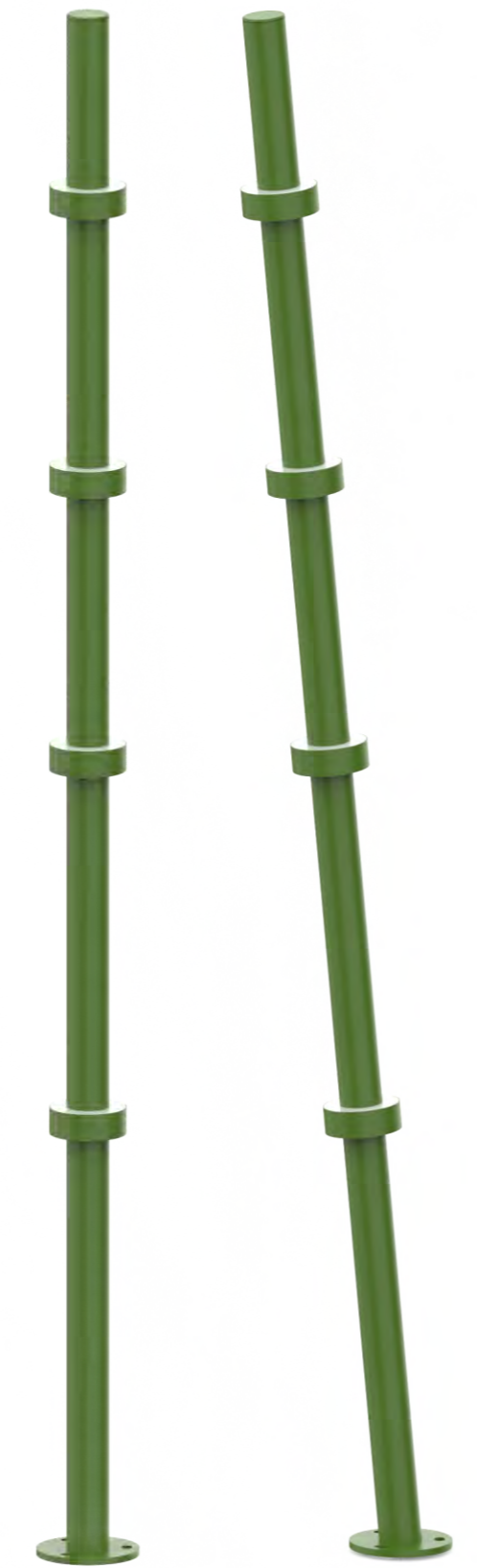
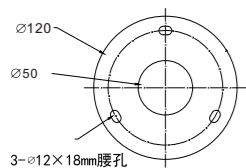
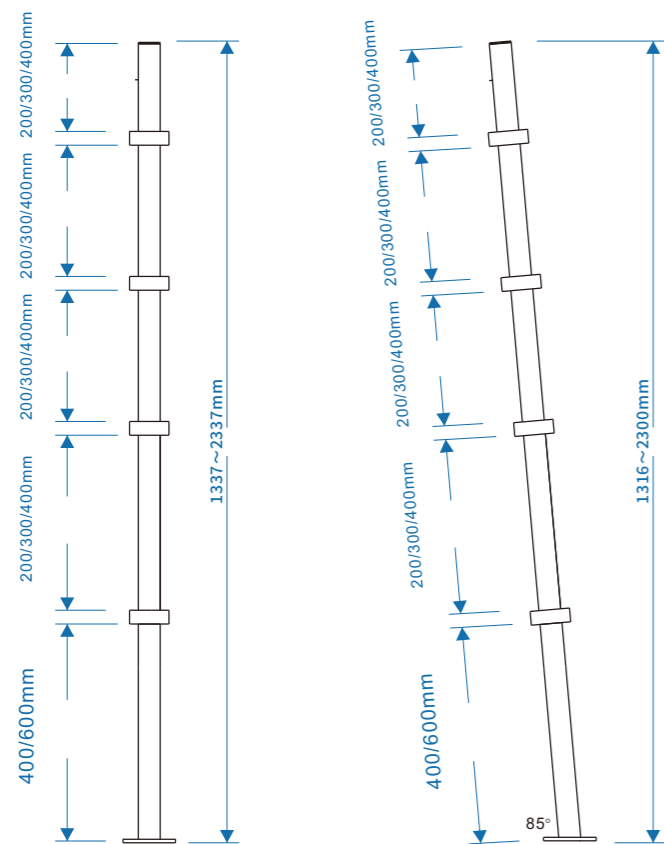

K50L4-B-E

K50R4-B-E

颜色: ■
Colour: Green

单位Unit: mm

灯具编号: K50L5-B-E/K50R5-B-E

Luminaire Serial Number: K50L5-B-E/K50R5-B-E

功率Power: 45W(5x9W/节)

光模组Light Module: 5组 (发光竹节x5)

防护等级IP Rating: Ip65

输入电压Input Voltage: DC24V

控制Control: DMX512

显色性Ra: Ra>85

色温CCT: RGB

光源品牌LED Brand: CREE / OSRAM

灯体颜色Painting Color: ■

环境温度Operating Temperature: -25°C~40°C

适用范围Scope of application: 户外Outdoor/室内Indoor

倾角Inclination: 90°/85°

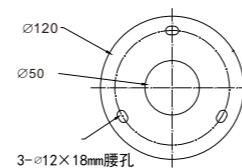
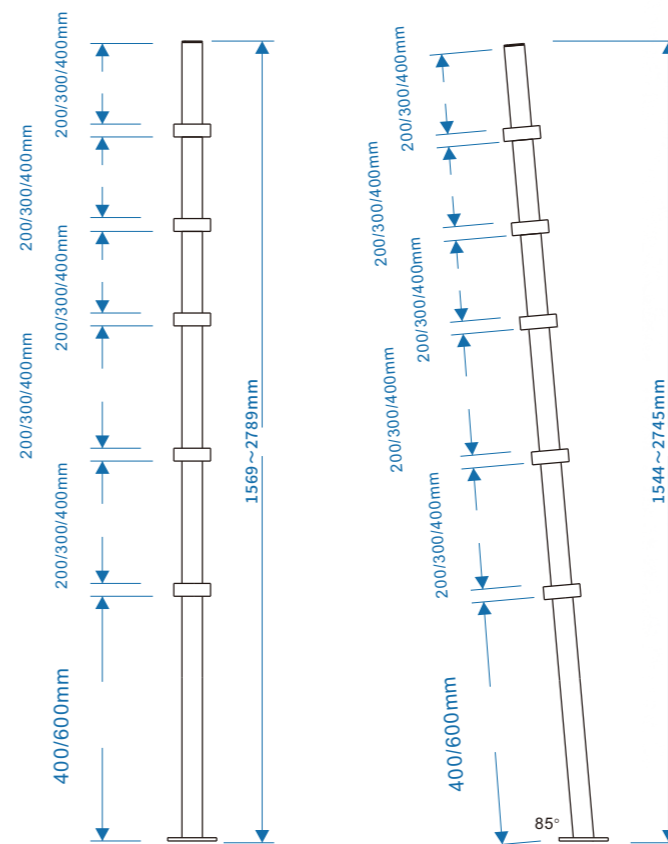

K50L5-B-E

K50R5-B-E

颜色: ■
Colour: Green

单位Unit: mm